

Groundwater review

Part I

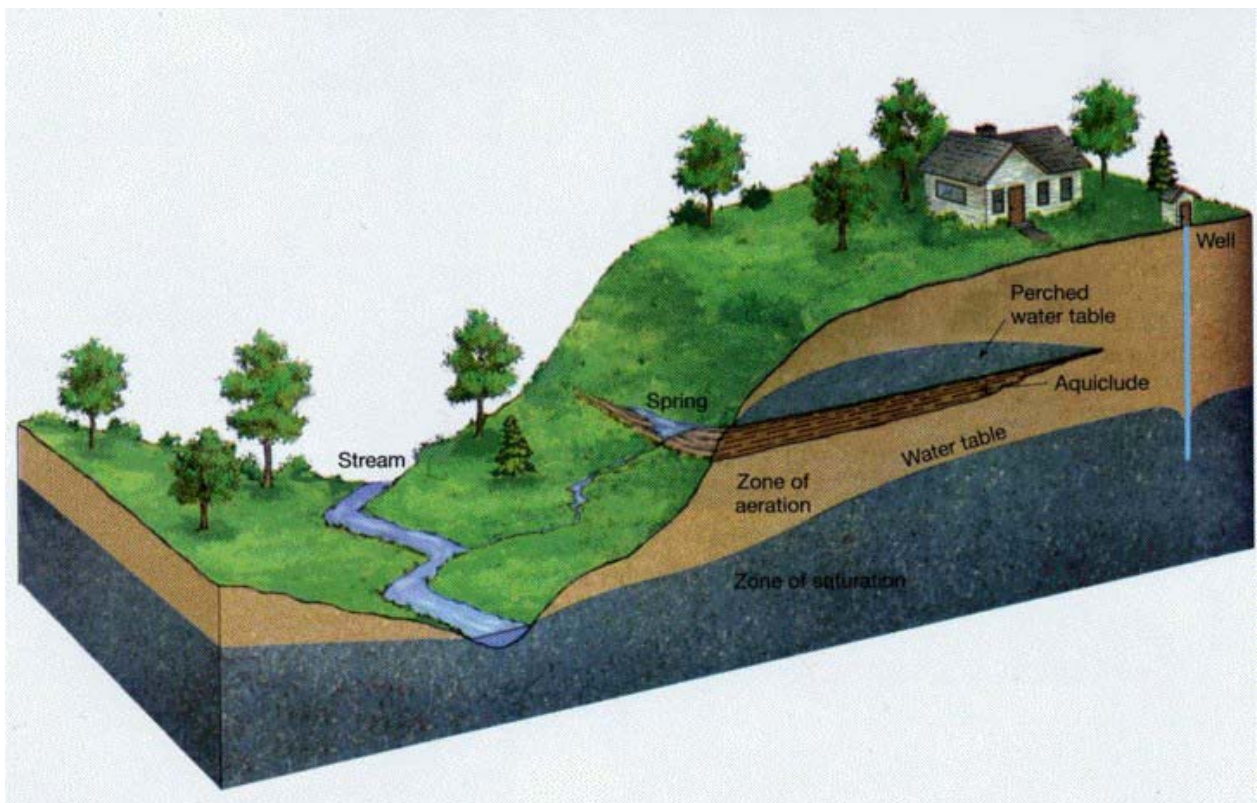

By: Amr A. El-Sayed
CEE VT, 2004

Selected Definitions used in Groundwater Hydrology

- Aquifer** - A formation, group of formations, or part of a formation that contains sufficient saturated permeable material to yield significant quantities of water to wells and springs. Aquifers can be artesian (confined), or unconfined. An unconfined aquifer has no confining beds between the zone of saturation and the aquifer, and the water table represents the top of the unconfined aquifer. The unconfined aquifer is also called a water-table aquifer. A **confined** aquifer is overlain by a confining bed such that the hydraulic head in the aquifer is above the height of the top of the aquifer.
- Aquitard** - A low-permeable unit that can store ground water and transmit it slowly from one aquifer to another.
- Capillary fringe** - the zone immediately above the water table in which all or some of the interstices are filled with water that is under less than atmospheric pressure and that is continuous with the water below the water table. Water is held above the water table by surface tension.
- Confining layer** - a body of material of low hydraulic conductivity that is stratigraphically adjacent to one or more aquifers. It may lie above or below the aquifer. Also called confining bed. If the bed is discontinuous and is represented as lenses of low conductivity material the lenses are referred to as interbeds.
- Drainage basin** - the land area from which surface runoff drains into a stream system.
- Fluid potential** - the mechanical energy per unit mass of a fluid at any given point in space and time with respect to an arbitrary state and datum. Ground water moves from a region of high fluid potential to a region of lower fluid potential. The movement of fluid represents a loss in mechanical energy, which is converted to heat by friction with the porous medium through which it travels.
- Head, total hydraulic** - represents the sum of three components: (1) elevation head, which is equal to the elevation above a datum, (2) pressure head, which is the height of a column of static water that can be supported by the static pressure at the point, and (3) velocity head, which is the height the kinetic energy of the fluid is capable of lifting the liquid.

Hydraulic Head:

$$h = \frac{P}{\gamma} + z$$

Where:

- h Hydraulic head (L) (m)
P Fluid pressure (Force/Area) (F/L²)
 γ Specific weight (Force/Volume) (F/L³)
z Elevation (L)

* γ (water) = 9810 Newton/m³ = 9.81 KN/m³

1 Pascal = N/m².

$$h(m) = \frac{P(KPa)}{\gamma(9.81KN/m^3)} + z(m)$$

GROUNDWATER

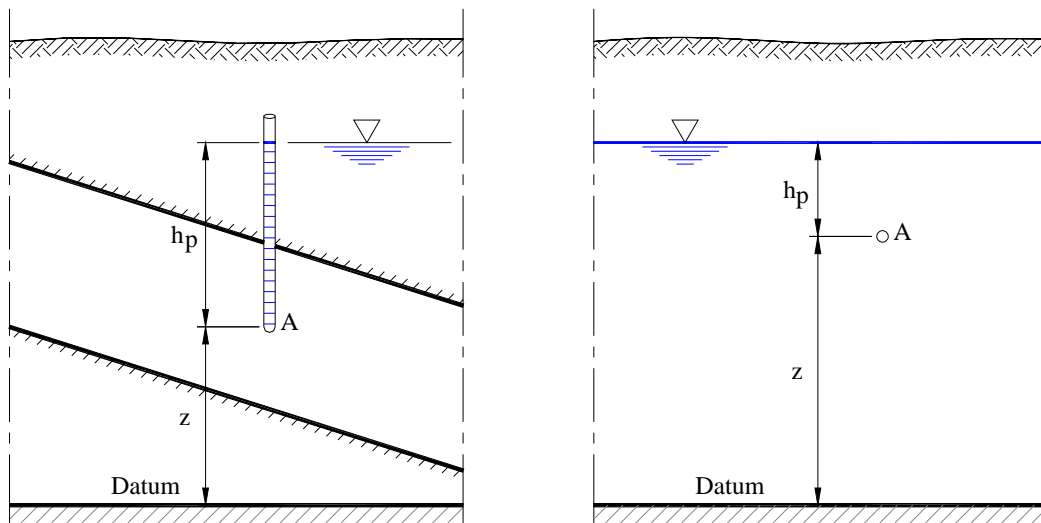

$$\text{Pressure} = \frac{\text{Force}}{\text{Area}} = \frac{\text{Force} \times L}{\text{Area} \times L} = \text{Potential energy / unit volume}$$

Hydraulic conductivity -

a coefficient of proportionality describing the rate at which water is transmitted through a unit width of aquifer under a unit hydraulic gradient.

$k = K \frac{\mu}{\rho g}$, is the intrinsic (basic and essential, of itself) permeability (dimensions of L^2).

$$k = K \left(\frac{L}{T} \right) \frac{\mu \left(\frac{M}{L.T} \right)}{\rho \left(\frac{M}{L^3} \right) g \left(\frac{L}{T^2} \right)} = L^2 \quad \rightarrow \text{Example } k = K \left(\frac{m}{\text{sec}} \right) \frac{\mu \left(\frac{kg}{m.\text{sec}} \right)}{\rho \left(\frac{kg}{m^3} \right) g \left(\frac{m}{\text{sec}^2} \right)} = m^2$$

$q = -K \frac{dh}{dl}$ is a one dimensional flow equation.

Hydraulic gradient -

is the change in static head per unit of distance in a given direction. Mathematically it is equal to the maximum rate of change in head and whose direction is that in which the maximum rate of decrease occurs.

$$\text{Hydraulic gradient} = \frac{\Delta h}{\Delta l} \quad (\text{dimensionless})$$

Permeability -

is a measure of the relative ease with which a porous medium can transmit a liquid under a potential gradient. It is a property of the medium alone and is independent of the nature of the liquid and of the force field causing movement.

Porosity -

a property of the rock or soil describing the void space between grains and may be quantitatively expressed as the volume of voids to its total volume. Effective porosity refers to the amount of interconnected pore space available for fluid transmission.

$$n = \frac{V_v}{V_t}$$

GROUNDWATER

Where:

- V_v Volume of voids
- V_t Total volume

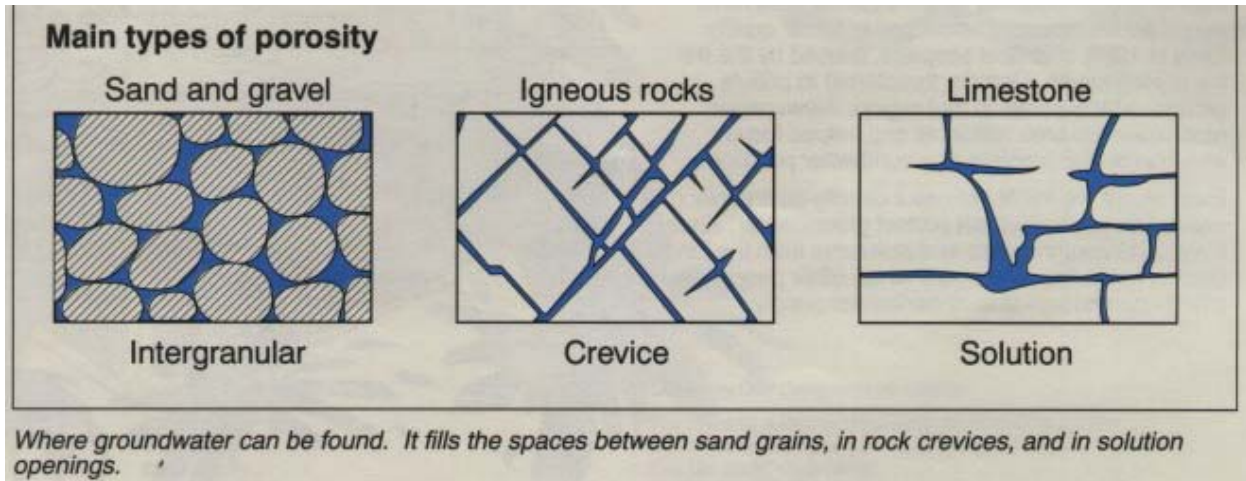

Voids ratio (e) = volume of voids / volume of solids $\rightarrow e = \frac{V_v}{V_s}$

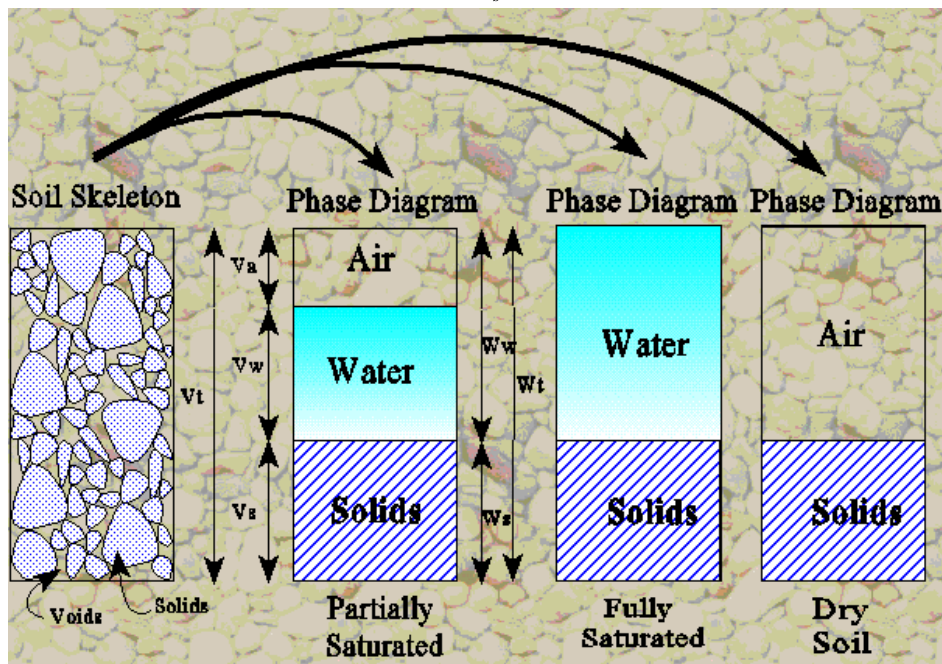

$$n = \frac{V_v}{V_t} = \frac{V_v}{V_s} \times \frac{V_s}{V_t} = e \frac{V_t - V_v}{V_t} = e \left(1 - \frac{V_v}{V_t} \right)$$

$$n = e(1 - n) \rightarrow e = \frac{n}{1 - n}$$

Potentiometric surface -

is a surface which represents the static head. As related to an aquifer, it is defined by the levels to which water will rise in tightly cased wells. Where the head varies appreciably with depth in the aquifer, a potentiometric surface is meaningful only

GROUNDWATER

if it describes the static head along a particular specified surface or stratum in that aquifer.

Specific capacity -

is the rate of discharge of water from a well divided by the drawdown of water level within the well.

Specific discharge -

is the rate of discharge of ground water per unit area measured at right angles to the direction of flow. Specific discharge has the dimensions of velocity. Also called the Darcian velocity.

$$\rightarrow \text{Specific discharge, } q = \text{discharge} / \text{total area} = \frac{Q}{A} \rightarrow q = k \cdot i$$

The specific discharge, q , also has units of [L/T]. However, it is important to realize that specific discharge is not the “speed” of groundwater flow, but the flow per unit area.

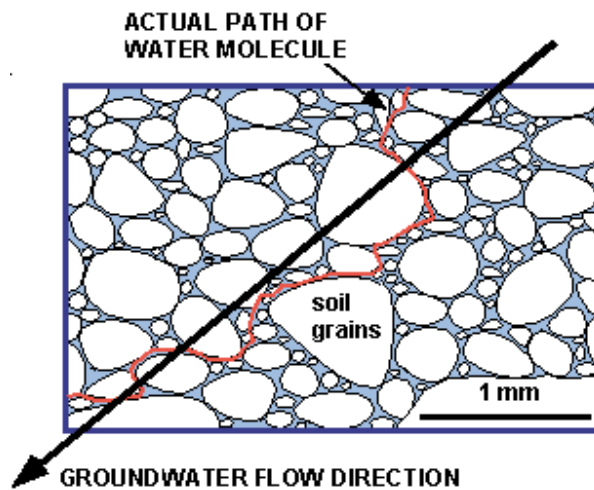

The velocity of an actual water particle moving in Darcy’s will, on average, be much greater than the value of specific discharge, because the water particle travels a tortuous path which is much longer than the macroscopic linearized path from one end of the experiment column to the other (Figure 1-1).

The average groundwater velocity can be estimated by dividing the specific discharge, q , by the porosity, n : $v = \frac{q}{n} = \frac{Q}{nA}$

Where v is the groundwater or “Darcy” velocity.

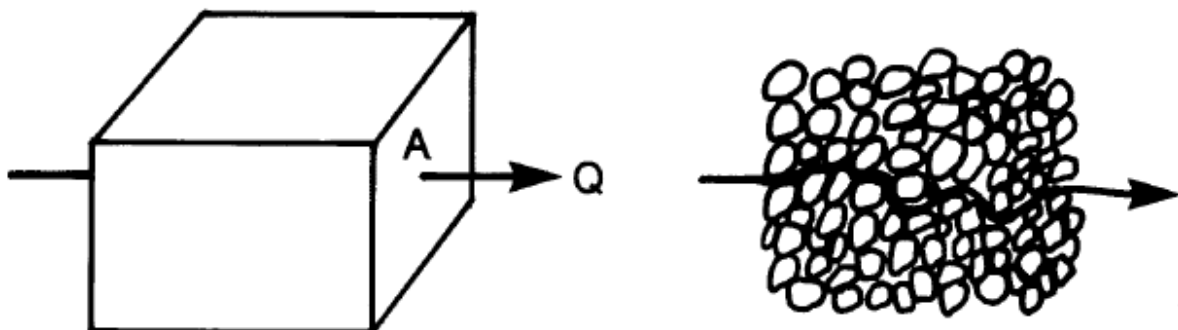

Fig. (1-1) , Concept of macroscopic and microscopic groundwater flow (after Freeze and Cherry, 1979).

Compressibility Compressibility reflects the stress-strain properties of a material:

Stress: internal response of a material to an external pressure

Strain: measure of the linear or volumetric deformation of a stressed material

For liquids, the compressibility is expressed by its Bulk Modulus of Elasticity:

$$E = \frac{-dP}{dV/V} \quad \text{units, N/m}^2$$

$$\text{Compressibility} \rightarrow \beta = \frac{1}{E}$$

- β (Compressibility of water) = $-dV_{\text{water}}$ “change in water volume”

Water is often considered incompressible, but it does have a finite, low compressibility.

As water pressure P rises an amount dP at a constant temperature, the density of water increases $d\rho_w$ from its original density ρ_w , and a given volume of water V_w will decrease in volume by dV_w in accordance with

$$\beta \times dP = \frac{d\rho_w}{\rho_w}$$

Where

β is the isothermal compressibility of water. Water compressibility varies only slightly within the normal range of groundwater temperatures, from $\beta = 4.9 \times 10^{-10} \text{ m}^2/\text{N}$ at 0°C to $\beta = 4.5 \times 10^{-10} \text{ m}^2/\text{N}$ at 20°C (Streeter and Wylie, 1979).

$$\beta = \frac{dV_w}{V_w dP} = -\frac{1}{V_w} \frac{dV_w}{dP} = \frac{1}{\rho} \frac{d\rho}{dP} \quad \rightarrow$$

- α (Compressibility of soil matrix) = dV_t “change in total volume”

Aquifer Compressibility: relative change in volume in response to unit change ineffective stress. For a confined aquifer of uniform cross-section, the relative change in volume is equal to the relative change in thickness $\frac{\Delta b}{b}$, where b is the initial

aquifer thickness. The aquifer compressibility is then given by: $\alpha = -\frac{1}{b} \frac{\Delta b}{\Delta \sigma_e} = \frac{1}{b} \frac{\Delta b}{\Delta P}$

Compressibility of aquifer, α : (only consider volume change in the vertical direction)

$$\alpha = dV_t = \frac{V_t}{d\sigma_e} \quad \rightarrow \quad \alpha \times dP = \frac{d(dz)}{dz}$$

Storativity:-

- The next aquifer property
- Becomes a factor when the aquifer loses or gains water
- Each aquifer has a different ability to expel or absorb water

GROUNDWATER

Storativity (S) **The volume of water that a permeable unit will absorb or expel from storage per unit surface area per unit change in head**

- Units: storativity is a dimensionless quantity
- Storativity is due to porosity in the aquifer

- **Storativity is different for confined and unconfined aquifers: will discuss this below**

- Aquifers also have *elastic* properties:
- This leads us to the concept of ***specific storage***:

Specific storage - **the volume of water released from or taken into storage per unit volume of the porous medium per unit change in head. It is used in problems in which three-dimensional transient flow is necessary to consider the amount of water taken into storage per unit volume of porous medium.**

Specific storage **Specific storage (S_s): The amount of water per unit volume of a saturated formation that is stored or expelled from storage owing to compressibility of the mineral skeleton and the pore water per unit change in head (also called the “elastic storage coefficient”)**

The term describes compressibility of the aquifer is (**Specific Storage**):

$$\text{Specific Storage } S_s = \frac{\text{Volume in/out storage}}{(\text{Total Volume}) * \Delta h}$$

The total volume is the volume from which the volume of water is derived.

- The specific storage is the volume of water removed or added to storage, per unit volume, per unit change in head. Thus, the specific storage units is L^{-1} (usually per foot).
- Is caused by pressure changes and the resulting expansion and contraction of the aquifer and the groundwater.
- Both the sediment (mineral skeleton) and the groundwater have elastic properties:

1) Elastic properties of the aquifer (mineral framework):

- With increasing pressure (hydraulic head):
 - Water exerts more pressure on the pore walls
 - Aquifer framework expands
 - Aquifer can store more water
- With decreasing pressure (hydraulic head):
 - Water exerts less pressure on the pore walls
 - Aquifer framework contracts
 - Aquifer stores less water

2) Elastic properties of the water:

- With increasing pressure (hydraulic head):
 - Water contracts
 - More water can be stored in each pore
 - Adds to the effects on the aquifer
- With decreasing pressure (hydraulic head):
 - Water expands
 - Less water can be stored in each pore
 - Again: less water stored in the aquifer

$$\text{Specific Storage, } S_s = \frac{1}{V_t} \frac{dV_w}{dh} \text{ (units of } L^{-1}\text{)}$$

$$\text{Specific Storage } (S_s) = \gamma(\alpha + n.\beta)$$

Where:

GROUNDWATER

γ	Specific weight of water = $\rho \cdot g$ = $1000 \text{ kg./m}^3 * 9.81 \text{ m/sec}^2$. = 9810 N/m^3 .
β	Compressibility of water = $4.4 * 10^{-10} \text{ (m}^2/\text{N)}$ or Pa^{-1} .
α	Compressibility of aquifer matrix
n	Porosity.

Specific storage, skeletal - refers to that portion of the specific storage that comes from compression of the skeletal matrix only. It does not include the water added to storage from water compressibility.

Summary

	With increasing pressure (head)	With decreasing pressure (head)
Elastic properties of the aquifer (mineral framework)	- Water exerts more pressure on pore walls - Aquifer framework expands - Aquifer can store more water	- Water exerts less pressure on pore walls - Aquifer framework contracts - Aquifer stores less water
Elastic properties of water	- Water contracts - More water can be stored in each pore - Aquifer can store more water	- Water expands - Less water can be stored in each pore - Aquifer stores less water

Storativity in confined and unconfined aquifers:

- When pumped, confined and unconfined aquifers behave differently
- Difference is due to storativity, specific yield

1) Confined aquifers:

- Aquifer is always completely saturated
- All water released is from compressibility of the aquifer (mineral skeleton and pore fluid)
- Storativity < 0.005 or (much) less

Storage Coefficient (S) – **confined aquifer**

Storage coefficient - the volume of water an aquifer releases from or takes into storage per unit surface area of the aquifer per unit change in head. It represents the water released from or taken up into storage in confined aquifers due to the compression or expansion of water and the compression or expansion of the aquifer matrix. In unconfined aquifers the storage coefficient is usually considered to be the specific yield because the water released by gravity drainage is usually much greater than the amount of water released by expansion of water and compression of the aquifer matrix.

$$\text{Storage Coefficient (S)} = \frac{\text{Volume in/out storage}}{(\text{Unit Area}) * \Delta h}$$

- Storage Coefficient (S) = $\frac{\Delta V_{\text{water}}}{A \cdot \Delta h} = S_s \cdot b$ (Dimensionless)

Where:

- S = storativity (storage coefficient of confined aquifer): amount of water expelled per unit surface area per unit change in head (the general term)
- b = aquifer thickness (units = L)
- S_s = specific storage (see above), units = 1/L

GROUNDWATER

The result: S is dimensionless

2) Unconfined aquifers:

- Saturation of aquifer varies
- *Storativity varies*, depending on gravity drainage from the pore spaces
- Specific yield (the gravity drainage factor) is much more important here

Specific yield - **the ratio of (1) the volume of water which the rock or soil, after being saturated, will yield by gravity to (2) the volume of the rock or soil. The definition implies that gravity drainage is complete. Specific yield is only an approximate measure of the relation between storage and head in unconfined aquifers. It is equal to porosity minus specific retention.**

Specific Yield (S_y) is a property for unconfined aquifers where Gravity drainage is a significant mechanism for the release of groundwater from storage in an aquifer.

$$S_y = \frac{V_{w(\text{drained})}}{V_t}$$

Where:

V_w Volume of water yielded by gravity drainage.
 V_t Total volume.

$$V_t = A \cdot \Delta h$$

A: cross sectional area
 Δh : drop of water height

$$\text{Specific Yield } S_y = \frac{\text{Gravity drainage volume "Volume of yielded water"}}{\text{Volume of porous medium drained "Total drained water volume"}}$$

$$\text{Specific Yield } S_y = \frac{\text{Volume in/out storage}}{(\text{Area drained}) \cdot \Delta h}$$

The term (dewatering) is equivalent to gravity drainage

For saturated conditions, Volume of water = volume of voids

Specific Yield versus Filling Porosity:

$$n > S_y$$

Specific Retention (S_r):

$$S_r = \frac{V_{w(\text{remained})}}{V_t}$$

V_w Volume of water retained following gravity.
 V_t Total volume.

$$n = S_y + S_r$$

In case of Recharge, the specific yield (S_y) is called (Filling porosity)

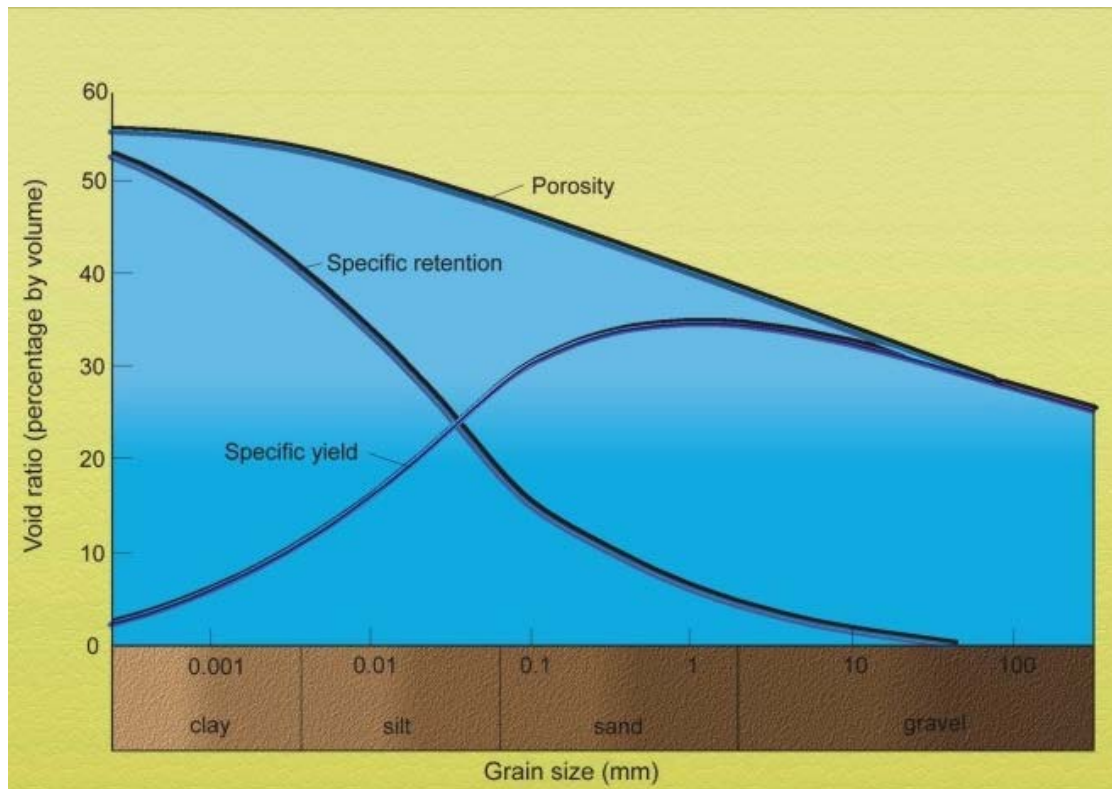

Other Mechanisms resulting in changes in groundwater storage are:

- 1- Compressibility of porous media:
 - Expansion/compression of water
 - Expansion/compression of aquifer matrix
- 2- Leakage from aquitards and clay layers.

When using dewatering well, the drop of pressure results in expansion of water, and compression of aquifer matrix.

Specific Yields for different soils

Material	Maximum	Minimum	Average
Clay	5	0	2
Sandy clay	12	3	7
Silt	19	3	18
Fine sand	28	10	21
Medium sand	32	15	26
Coarse sand	35	20	27
Gravelly sand	35	20	25
Fine gravel	35	21	25
Medium gravel	26	13	23
Coarse gravel	26	12	22

Specific retention - of a rock or soil is the ratio of (1) the volume of water which the rock or soil, after being saturated, will retain against the pull of gravity to (2) the volume of rock or soil. The definition implies that gravity drainage is complete although this is rarely ever the case.

GROUNDWATER

$$S_r = \frac{V_{w(\text{retained})}}{V_t}$$

Where:

V_w Volume of water retained following gravity.
 V_t Total volume. ($n = S_y + S_r$)

- Remember: specific yield (S_y) is the ratio of the volume of water that drains from a saturated rock (owing to the attraction of gravity) to the total volume of the rock

Storage coefficient (unconfined), $S = S_y + h \times S_s$

Where:

S = storativity, or storage coefficient, (volume of water that a permeable unit will absorb or expel from storage per unit surface area per unit change in head (dimensionless))
 S_y = specific yield = the gravity drainage factor
 h = thickness of the saturated zone
 S_s = the compressibility factor
- Note: S_y is several orders of magnitude greater than $h S_s$
- Storativity for an unconfined aquifer: ranges 0.02 to 0.3
- Storativity is highly dependant on grain size

Volume estimates of storativity:

- Accomplished with a simple transformation: include the area of the aquifer
- Formula:
 - o $V_w = S \times A \times \Delta h$

Where A = area of the aquifer
 Δh = average decline in head (ft)
 S = Storativity (dimensionless)

Specific Yield (S_y) is much greater than Storage Coefficient (S), for example if ($n = 0.30$), you may find that $S_y = 0.12$, and $S = 0.005$.

For the same Δh , unconfined aquifer yields much more water than a confined aquifer.



Transmissivity - is the rate at which water is transmitted through a specified thickness of aquifer that has a unit width and is under a unit hydraulic gradient.

Transmissivity: Another aquifer property, moves beyond the concept of Darcy's hydraulic conductivity

Transmissivity A measure of the amount of water that can be transmitted horizontally through a unit width by the full saturated thickness of the aquifer under a hydraulic gradient of 1.

- Think of this as a " window frame" in the aquifer
- How much water can pass through the window frame?
- Note: assumes horizontal groundwater movement
- This isn't always true

$$T = K.b$$

where: T = transmissivity, units = L^2/T , common units: ft^2/d , m^2/d , cm^2/s
 K = hydraulic conductivity, units = L/T , common units: ft/d , m/d , cm/s

GROUNDWATER

b = saturated thickness of the aquifer, units =L, common units: ft, m

- This adds a second dimension that was missing when we talked about hydraulic conductivity

- Transmissivity can be summed for multilayer aquifers:

$$T = \sum_{i=1}^n T_i \quad (\text{sum from } i=1 \text{ to } n \text{ of } T_i)$$

Velocity, average linear -

is the specific discharge divided by the effective porosity. It represents the particle velocity whereas the specific discharge represents the average volume rate of flow per unit cross-sectional area.

Water table -

the saturated water surface in an unconfined aquifer where the pressure is atmospheric. It is defined by the levels at which water stands in wells that penetrate the water body just far enough to hold standing water.



Driving forces of groundwater flow

1- pressure force:

Total pressure force in the direction of flow:

$$p_1(nA) - p_2(nA)$$

Where

n porosity

p_1 pressure at section 1

A Cross-sectional area

p_2 pressure at section 2

$$= nA(p_1 - p_2) = nA\Delta p$$

Multiply by $\frac{\Delta l}{dl}$, and replace Δp by dp

$$F_p = -\frac{dp}{dl} \Delta l \times nA$$

2- Gravitational forces:

Mass of the fluid = volume \times density = $\Delta l(nA) \times \rho$

Weight = mass \times acceleration due to gravity

$$F_w = mg \quad F_w = \Delta l(nA) \times \rho g$$

The weight component in the direction of flow (assuming an angle α with vertical axis), F_i ,

GROUNDWATER

$$F_l = \Delta l(nA) \times \rho g \times \cos \alpha$$

$$\cos \alpha = \frac{\Delta z}{\Delta l}$$

$$F_l = \Delta l(nA) \times \rho g \times \frac{\Delta z}{\Delta l}$$

Using that equation in a derivative form:

$$F_l = -\Delta l(nA) \times \rho g \times \frac{dz}{dl}$$

Net force on the flow = pressure force – gravitational force = $F_p - F_l$

$$F_{net} = -\frac{dp}{dl} \Delta l \times nA - \Delta l(nA) \times \rho g \times \frac{dz}{dl}$$

$$F_{net} = \left(-\frac{dp}{dl} - \rho g \times \frac{dz}{dl} \right) \Delta l(nA)$$

The force per unit volume = $F_{net} = \left(-\frac{dp}{dl} - \rho g \times \frac{dz}{dl} \right)$

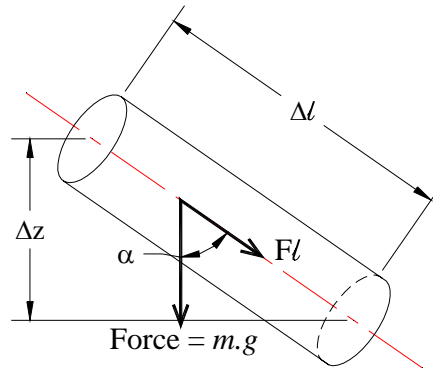

3- Force opposing the flow

We assume the opposing force is the frictional force, F_f

Assumptions:

- a- F_f to be proportional to the specific discharge, $q = \frac{Q}{A}$
- b- F_f to be proportional to the volume of fluid in the element, $V = (\Delta l \times nA)$
- c- F_f to be proportional to the dynamic viscosity of the fluid, $\mu = \tau / \frac{dv}{dy}$

$$\tau = \mu \frac{dv}{dy} \quad \mu = \tau / \frac{dv}{dy} = \text{Shear stress / velocity gradient}$$

Where:

τ Shear stress (N/m^2)

μ Absolute (dynamic) viscosity, which measures ability of a fluid to flow

The units of μ are " $Pa \cdot s = \frac{N \cdot s}{m^2} = \frac{kg \cdot m}{s^2} \frac{s}{m^2} = \frac{kg}{m \cdot s}$ " or " $\frac{lb \cdot sec}{ft^2}$ "

Kinematic Viscosity = Absolute Viscosity/ density

GROUNDWATER

$$\nu = \frac{\mu}{\rho} = \frac{N.s}{m^2} / \frac{kg}{m^3} = \frac{kg.m.s}{s^2 m^2 kg} = \frac{m^2}{s} \text{ (stokes)}$$

$$F_r \propto \frac{Q}{A} \quad F_r \propto (\Delta l \times nA) \quad F_r \propto \mu$$

$$F_r = -\frac{1}{k} \mu (\Delta l \times nA) \frac{Q}{A}$$

The negative sign indicates that the frictional retarding force will be opposite to the flow direction.

For steady state, driving forces + retarding forces = zero

$$-\left(\frac{dp}{dl} + \rho g \times \frac{dz}{dl}\right) \Delta l (nA) - \frac{1}{k} \mu (\Delta l \times nA) \frac{Q}{A} = 0$$

$$-\left(\frac{dp}{dl} + \rho g \times \frac{dz}{dl}\right) = \frac{\mu Q}{k A}$$

$$-\frac{k}{\mu} \left(\frac{dp}{dl} + \rho g \times \frac{dz}{dl}\right) = \frac{Q}{A}$$

Assume:

1- ρ and μ are constants

2- put $K = \frac{k\rho g}{\mu} \rightarrow \frac{K}{\rho g} = \frac{k}{\mu}$

$$-\left(\frac{k}{\mu} \frac{dp}{dl} + \frac{k\rho g}{\mu} \times \frac{dz}{dl}\right) = \frac{Q}{A} \quad -\left(\frac{K}{\rho g} \frac{dp}{dl} + K \times \frac{dz}{dl}\right) = \frac{Q}{A}$$

$$-K \left(\frac{1}{\rho g} \frac{dp}{dl} + \frac{dz}{dl}\right) = \frac{Q}{A} \quad \dots\dots\dots \text{(#1)}$$

Consider the derivative: $\frac{1}{4} \frac{dx^3}{dx} = \frac{1}{4} \times 3x^2 = \frac{d\left(\frac{x^3}{4}\right)}{dx}$, then $\frac{1}{\rho g} \frac{dp}{dl} = \frac{d\left(\frac{dp}{\rho g}\right)}{dl}$

$$h = z + \frac{p}{\rho g} \rightarrow \frac{dh}{dl} = \frac{d\left(z + \frac{p}{\rho g}\right)}{dl} = \frac{dz}{dl} + \frac{d\left(\frac{p}{\rho g}\right)}{dl} = \frac{dz}{dl} + \frac{1}{\rho g} \frac{dp}{dl}$$

$$\text{Substitute in \#1, } -K \left(\frac{1}{\rho g} \frac{dp}{dl} + \frac{dz}{dl}\right) = \frac{Q}{A} \rightarrow -K \frac{dh}{dl} = \frac{Q}{A}$$

GROUNDWATER

The equation, $-K \frac{dh}{dl} = \frac{Q}{A}$ was verified experimentally by Darcy (1856)

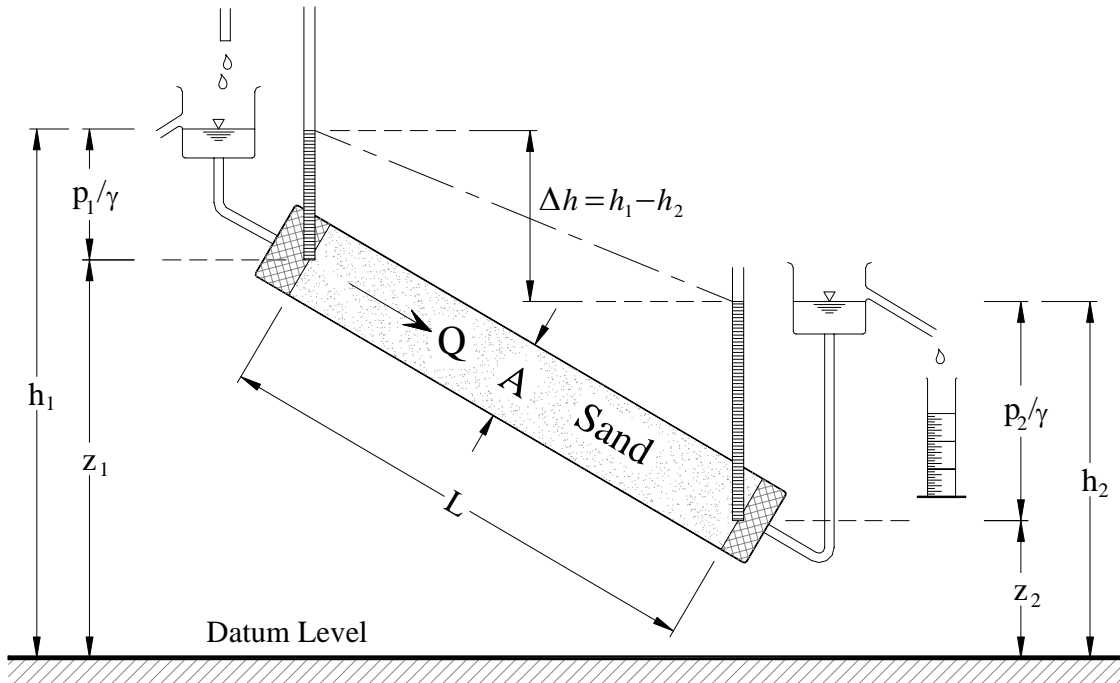

$\frac{Q}{A} = -K \frac{dh}{dl}$ (#2) Darcy's Equation

Where

K Hydraulic conductivity (dimensions of velocity, L/T)

Hydrologic budget

A) Processes in the hydrologic cycle:

- 1) Precipitation
- 2) Evaporation: a physical/chemical response
- 3) Transpiration: needs plants
Plants act as pumps: remove water from the soil, release water vapor into the atmosphere.
- 4) Runoff:
 - Is commonly known as stream or channel flow
 - Has 3 components: overland flow, interflow and underflow
(Doesn't just include surface flow)

GROUNDWATER

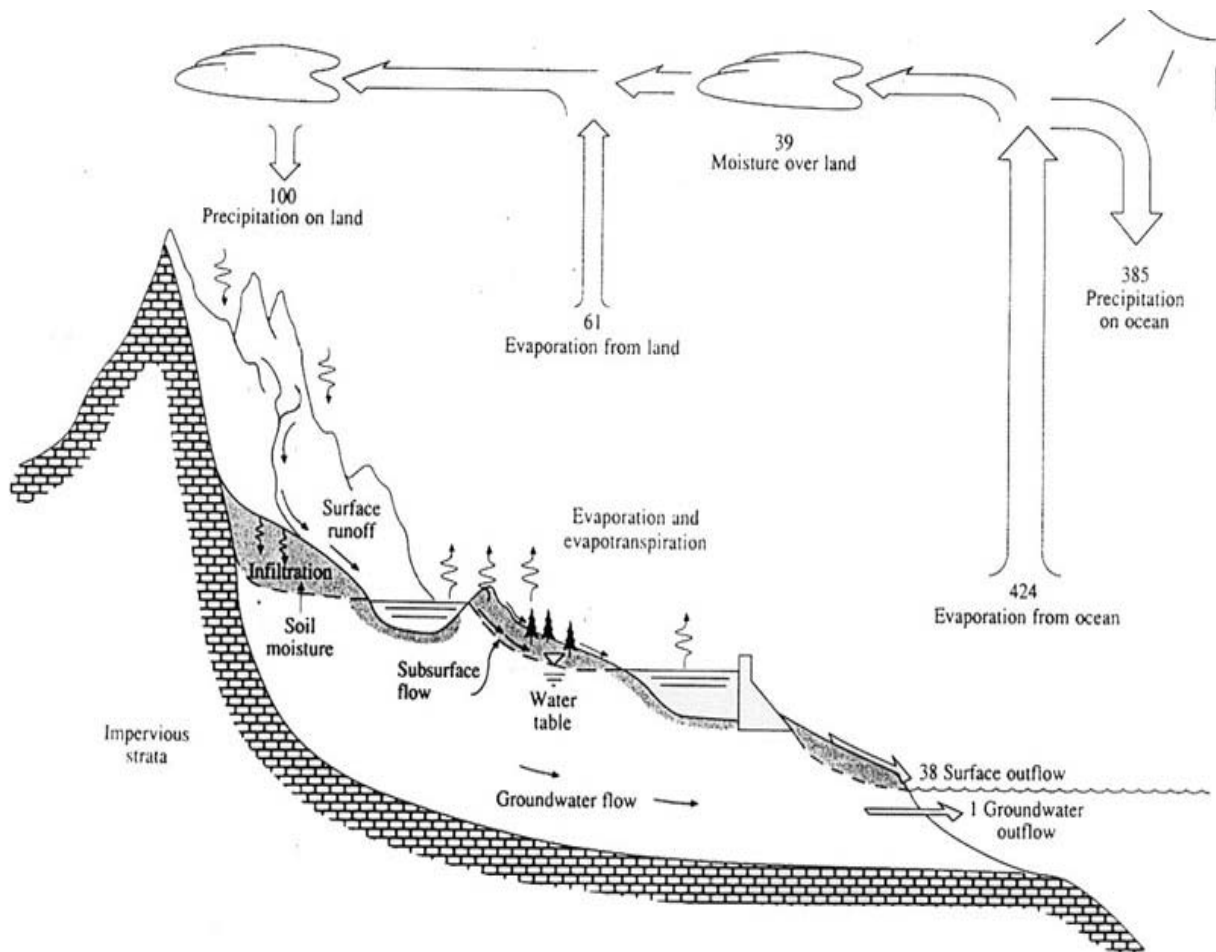

a) **overland flow** = flow input from land surface drainage across the land surface (not channelized)

Side note: The terms “overland flow”, “depression storage” and “surface water” are all different. Don’t confuse them!

Overland flow is moving water

Depression storage is water that accumulates in low spots and is essentially stationary. A common name for depression storage? A puddle!

Surface water is water that is stored in ponds, lakes, rivers and streams. This is a broader term, that includes runoff.

b) **interflow**:

Quantity is usually minor

Describes lateral flow through the unsaturated (soil) zone (Note: unsaturated zone is also called the vadose zone)

The process by which surface water enters the subsurface is called **infiltration**; almost all of the water in the subsurface is placed there by infiltration. The only exception is **magmatic water**, which is added from depth due to de-gassing of magma.

c) **baseflow** = groundwater input

Describes lateral flow in the saturated zone (below the water table) that contributes to stream flow.

Note: **Underflow** is different. Underflow is deep groundwater flow, and is not directly connected to surface flow or surface conditions.

GROUNDWATER

So: In summary, total stream flow (runoff) is the sum of 3 components:
Runoff = overland flow + interflow + baseflow

B) Water storage within the hydrologic cycle:

- Most water is stored as saline water in the oceans (97%)
- Freshwater: is < 3% of total
- Within the freshwater component:
 - Glacial storage = 2.14%
 - Groundwater storage = 0.61%
 - Surface water storage = 0.009%
 - Soil moisture = 0.005%
 - Atmospheric moisture = 0.001%
- Other ways of looking at this:
 - 98% of available freshwater is groundwater, <2% is surface water
 - Groundwater is almost 68 times more abundant than surface water
- Explains the bias of this course toward groundwater.

C) The Hydrologic Equation:

- The general equation: Is essentially a problem of conservation of mass:

Inflow = outflow +/- storage OR: Inflow - Outflow = change in storage

Inflow = precipitation, surface inflow, loss from a body of surface water, subsurface inflow, overland flow, groundwater discharge into a body of surface water.

Outflow = evaporation, transpiration, surface outflow, soil evaporation, loss of water through a stream bed, loss of water to a body of surface water, loss to vegetation, percolation to the water table, pumpage, removal to a water supply.

Change in storage = increase or decrease in subsurface storage, increase or decrease in surface storage.

- Fetter has written a more specific equation to represent the hydrologic cycle from the perspective of an aquifer:

$$P = R + T + E \text{ +/- } U \text{ +/- Storage terms}$$

where: P = precipitation R = runoff
T = transpiration E = evaporation
U = underflow

Hydrologic equation

$$(R + Q_{gwi} + Q_{Ri}) - (Q_p + Q_{gwo} + Q_{Ro}) = \frac{\Delta V_w}{\Delta t}$$

Where:

R Recharge to groundwater system
 Q_{gwi} Groundwater inflow
 Q_{Ri} Inflow from surface water
 Q_p Groundwater pumping
 Q_{gwo} Groundwater outflow
 Q_{Ro} Discharge to surface water
 ΔV Change in storage of groundwater

Discussion:

1) The term Interflow has been omitted from this hydrologic equation: it usually isn't very important volumetrically.

II) Quantifying components of the hydrologic equation

GROUNDWATER

- Each of the terms in the hydrologic equation can be quantified:
- Information about the hydrologic cycle is useful for computer modelers, water budgets, water rights, legislators

1) Quantifying Precipitation:

- Is measured with a rain gage
- Individual measurements are simple
- BUT: studies have shown wide variation between closely-spaced rain gages (up to 50% variability!!!)
- Process isn't as simple as it seems
- Yearly or Aerial or predictive measurements are very difficult:
 - Involves averaging of non-linear data
 - Hydrogeologists go crazy with this stuff

2) Quantifying storage terms:

- Can also be measured or estimated fairly easily
- a) +/- water exports (human induced)
 - ex: reservoirs, Central Valley aqueduct
 - can be measured with pumping rates, volume of reservoirs, flow in channels
- b) Soil moisture:
 - Measured in the lab:
 - Take a "wet" soil, weigh the soil
 - Dry the soil in an oven (usually at 60°C)
 - Weigh the dried soil
 - Weight difference = soil moisture
- c) +/- groundwater storage (will talk about this later when we talk about aquifers)

3) Quantifying Evaporation:

- E or ET: is often the largest component of the hydrologic equation!
- Evaporation is measured with a large basin of water (called a "land pan").
 - Pan is 4 ft. wide x 10" deep
 - National weather service and US Forest Service commonly make these measurements. NWS maintains 450 land pans around the country.
- Steps to measuring evaporation:
 - a) Fill the basin
 - b) Record temperature, area exposed...
 - c) Measure the amount of water in the basin after a time interval
 - d) Calculate the volume of water that evaporated within the given time. (Note: also need to account for precipitation added in the given time!)
- Evaporation varies with: wind velocity, temperature, elevation (barometric pressure), water depth, cloud cover, incident solar radiation, reflectivity (albedo) and relative humidity.
- Evaporation can be estimated from tables- is mostly temperature dependant.
- Errors in measurement may result from: very heavy rainfall, animals splashing in the pan etc. Also: a 10" land pan warms up much faster (on a daily basis) than a large lake.
- So: measurements are +/- 10%

Continuity Equation

In Darcy's equation, we generally don't know the specific discharge (q) or hydraulic head (h), (or we know the head but not the hydraulic conductivity K). Hence, we have two unknowns and one equation. In order to eliminate one of the unknowns we need another expression that also has these variables present. This is where continuity comes in to play.

Charles Slichter, 1899, developed the continuity equation for fluid flow through a fixed volume, or control volume. The equation states that "*the sum of all fluid flows into or out of the control volume plus or minus any process which consumes or creates fluid within the control volume must equal a change in the volume of the fluid within the control volume*". Mathematically, the equation is:

GROUNDWATER

Mass Flow Rate (In) – Mass Flow Rate (out) = Δ Fluid Mass / Δ time

Net flux (Inflow – Outflow) = Mass accumulation rate

Or more simply:

$$\frac{\partial M}{\partial t} = I - O \text{ (Change of mass with respect to time = Inflow discharge - Outflow discharge)}$$

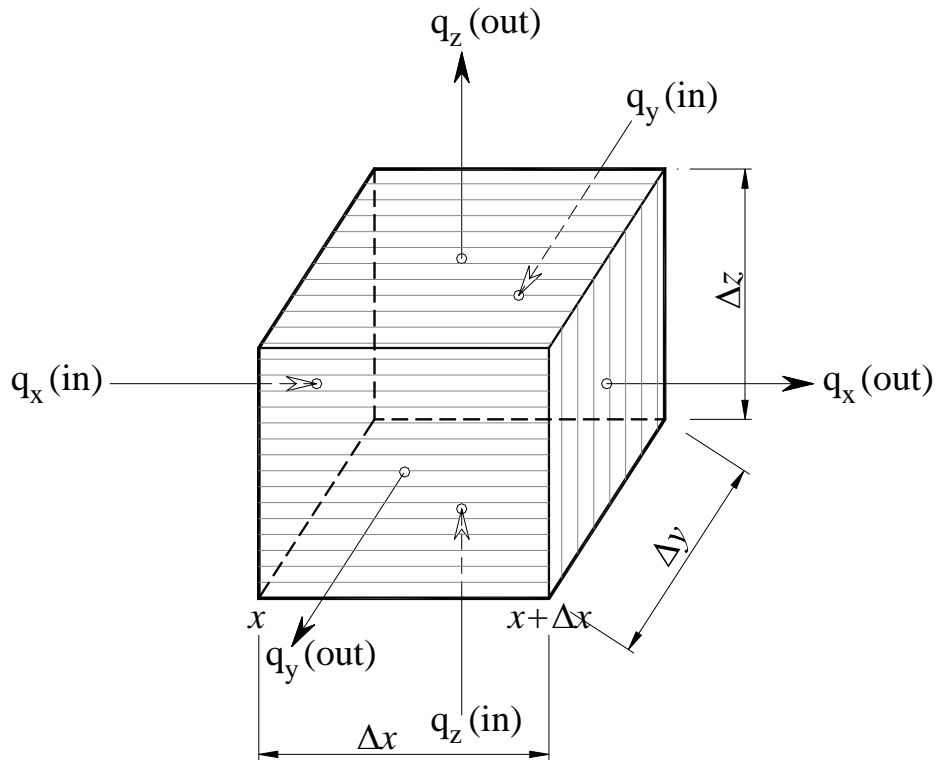

$$-[\rho \cdot q_x(x + \Delta x) - \rho \cdot q_x(x)] \cdot \Delta y \Delta z - [\rho \cdot q_y(y + \Delta y) - \rho \cdot q_y(y)] \cdot \Delta x \Delta z - [\rho \cdot q_z(z + \Delta z) - \rho \cdot q_z(z)] \cdot \Delta x \Delta y + \rho \cdot Q_{Source/Sink} = \frac{dM}{dt}$$

Divide the equation by $(\Delta x \cdot \Delta y \cdot \Delta z)$ "Total Volume"

$$\frac{-[\rho \cdot q_x(x + \Delta x) - \rho \cdot q_x(x)]}{\Delta x} - \frac{[\rho \cdot q_y(y + \Delta y) - \rho \cdot q_y(y)]}{\Delta y} - \frac{[\rho \cdot q_z(z + \Delta z) - \rho \cdot q_z(z)]}{\Delta z} + \frac{\rho \cdot Q_{Source/Sink}}{V_t} = \frac{1}{V_t} \frac{dM}{dt}$$

When $\Delta x \rightarrow 0$: $\frac{-[\rho \cdot q_x(x + \Delta x) - \rho \cdot q_x(x)]}{\Delta x} \rightarrow \frac{\partial}{\partial x} \rho \cdot q_x$

GROUNDWATER

$$-\left[\frac{\partial}{\partial x} \rho \cdot q_x + \frac{\partial}{\partial y} \rho \cdot q_y + \frac{\partial}{\partial z} \rho \cdot q_z \right] + \frac{\rho \cdot Q_{Source/Sink}}{V_t} = \frac{1}{V_t} \frac{dM}{dt}$$

Put $\frac{Q_{Source/Sink}}{V_t} = \pm W$

Assuming ρ is not spatially dependent; divide both sides of the above equation on ρ .

$$-\left[\frac{\partial}{\partial x} q_x + \frac{\partial}{\partial y} q_y + \frac{\partial}{\partial z} q_z \right] \pm W = \frac{1}{\rho \cdot V_t} \frac{dM}{dt}$$

($\frac{Mass}{Density} = Volume$) $\frac{dM}{\rho} = dV_w$

$$-\left[\frac{\partial}{\partial x} q_x + \frac{\partial}{\partial y} q_y + \frac{\partial}{\partial z} q_z \right] \pm W = \frac{1}{V_t} \left[\frac{\partial h}{\partial t} \cdot \frac{dV_w}{dh} \right]$$

but, Specific Storage (S_s) = $\frac{\Delta V_{water}}{V_t \cdot \Delta h}$, replace $\frac{dV_w}{dh}$ with (S_s)

and, $q_x = K_{xx} \cdot i_x = K_{xx} \cdot \frac{\partial h}{\partial x}$

The general equation for flow in 3-D becomes:

$$\frac{\partial}{\partial x} \left(K_{xx} \cdot \frac{\partial h}{\partial x} \right) + \frac{\partial}{\partial y} \left(K_{yy} \cdot \frac{\partial h}{\partial y} \right) + \frac{\partial}{\partial z} \left(K_{zz} \cdot \frac{\partial h}{\partial z} \right) + W = S_s \cdot \frac{\partial h}{\partial t}$$

1. **Heterogeneous isotropic:**

If flow is aligned with principle axes, $\bar{K} = \begin{bmatrix} K_{xx} & 0 & 0 \\ 0 & K_{yy} & 0 \\ 0 & 0 & K_{zz} \end{bmatrix}$

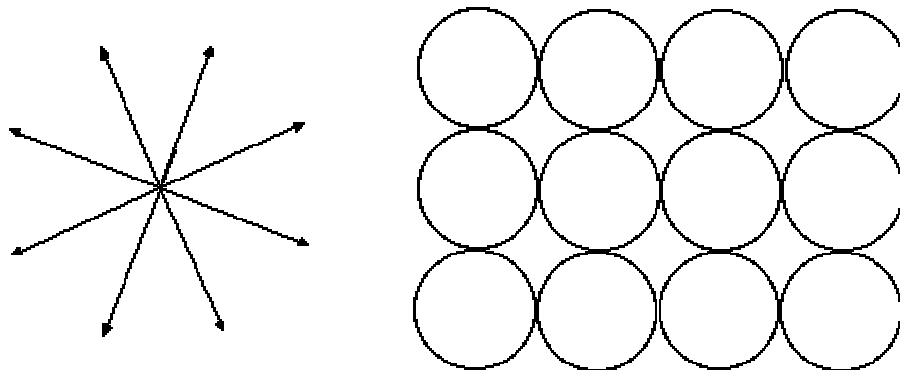

Isotropic

For isotropic conditions, $K_{xx} = K_{yy} = K_{zz} = K$, but it is heterogeneous (function of space)

$$\nabla \cdot (\bar{K} \nabla h) = \frac{\partial}{\partial x} \left(K \frac{\partial h}{\partial x} \right) + \frac{\partial}{\partial y} \left(K \frac{\partial h}{\partial y} \right) + \frac{\partial}{\partial z} \left(K \frac{\partial h}{\partial z} \right) = S_s \frac{\partial h}{\partial t}$$

2. Anisotropic and homogeneous

Homogenous (refers to spatial “space”) = K in x-direction are equal in any point in space.

i.e.:

$$K_{xx} = K_{yx} = K_{zx} = K_x$$

$$K_{yy} = K_{xy} = K_{zy} = K_y$$

$$K_{zz} = K_{xz} = K_{yz} = K_z$$

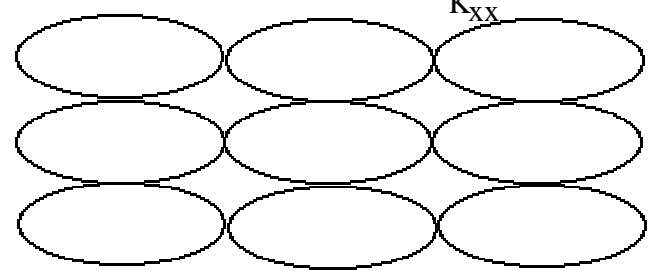
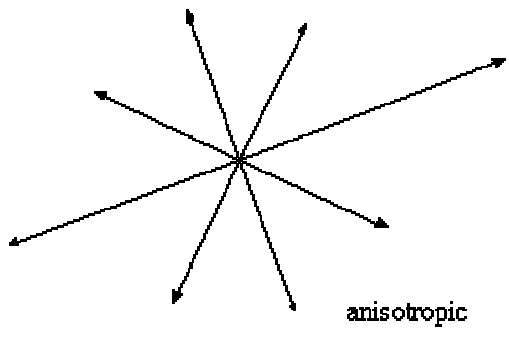
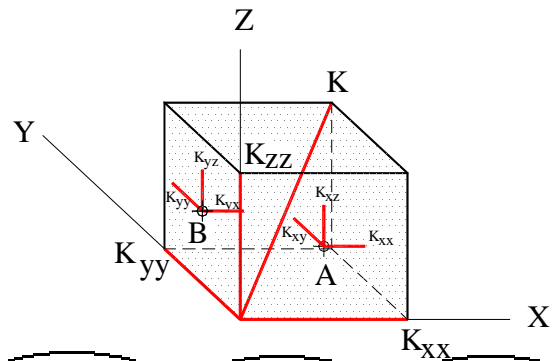

$$\frac{\partial}{\partial x} \left[K_x \frac{\partial h}{\partial x} + K_y \frac{\partial h}{\partial y} + K_z \frac{\partial h}{\partial z} \right] + \frac{\partial}{\partial y} \left[K_x \frac{\partial h}{\partial x} + K_y \frac{\partial h}{\partial y} + K_z \frac{\partial h}{\partial z} \right]$$

$$+ \frac{\partial}{\partial z} \left[K_x \frac{\partial h}{\partial x} + K_y \frac{\partial h}{\partial y} + K_z \frac{\partial h}{\partial z} \right] = S_s \frac{\partial h}{\partial t}$$

If flow is aligned with principle axes:

$$\frac{\partial}{\partial x} \left[K_x \frac{\partial h}{\partial x} \right] + \frac{\partial}{\partial y} \left[K_y \frac{\partial h}{\partial y} \right] + \frac{\partial}{\partial z} \left[K_z \frac{\partial h}{\partial z} \right] = S_s \frac{\partial h}{\partial t}$$

$$K_x \frac{\partial^2 h}{\partial x^2} + K_y \frac{\partial^2 h}{\partial y^2} + K_z \frac{\partial^2 h}{\partial z^2} = S_s \frac{\partial h}{\partial t}$$

3. Homogeneous and isotropic

$$K \frac{\partial^2 h}{\partial x^2} + K \frac{\partial^2 h}{\partial y^2} + K \frac{\partial^2 h}{\partial z^2} = S_s \frac{\partial h}{\partial t}$$

$$\frac{\partial^2 h}{\partial x^2} + \frac{\partial^2 h}{\partial y^2} + \frac{\partial^2 h}{\partial z^2} = \frac{S_s}{K} \frac{\partial h}{\partial t}$$

4. Heterogeneous and anisotropic

$$\nabla \cdot (\bar{K} \nabla h) = \frac{\partial}{\partial x} \left(K_{xx} \frac{\partial h}{\partial x} \right) + \frac{\partial}{\partial y} \left(K_{yy} \frac{\partial h}{\partial y} \right) + \frac{\partial}{\partial z} \left(K_{zz} \frac{\partial h}{\partial z} \right) = S_s \frac{\partial h}{\partial t}$$

Because we will be dealing with MODFLOW and finite differences, the mass balance expression can be written in an alternative form. First we recognize that the divergence of specific discharge represents the inflow – outflow of the entire region of interest (finite-difference grid). That is:

$$\frac{\sum Q_i}{\Delta V} = \nabla \cdot q$$

Then the groundwater flow equation can be rewritten as:

$$\sum Q_i = S_s \frac{\Delta h}{\Delta t} \Delta V$$

STEADY STATE FLOW: The flow and the head do not change with time. Therefore there is no dependence on time, and the right hand side of equation (2) can be neglected. The governing equation reduces to:

$$\frac{\partial}{\partial x} \left(K_x \cdot \frac{\partial h}{\partial x} \right) + \frac{\partial}{\partial y} \left(K_y \cdot \frac{\partial h}{\partial y} \right) + \frac{\partial}{\partial z} \left(K_z \cdot \frac{\partial h}{\partial z} \right) = 0 \quad \text{for heterogeneous, anisotropic case (3a)}$$

$$\frac{\partial^2 h}{\partial x^2} + \frac{\partial^2 h}{\partial y^2} + \frac{\partial^2 h}{\partial z^2} = 0 \quad \text{for homogeneous, isotropic case (3b)}$$

TRANSIENT FLOW: The change in fluid storage is directly proportional to the change in hydraulic head:

$$\frac{1}{\rho_w} \frac{\partial(\rho_w n)}{\partial t} = S_s \frac{\partial h}{\partial t} \quad \dots\dots\dots (4)$$

Where the constant S_s is called the *specific storage*. We will derive later an explicit relation for the specific storage in terms of the compressibility of water, and the porosity and compressibility of the solid.

With the above definition for the specific storage, we can rewrite the governing equation (2c) for *transient flow in a homogeneous, isotropic medium* as follows:

$$\frac{\partial^2 h}{\partial x^2} + \frac{\partial^2 h}{\partial y^2} + \frac{\partial^2 h}{\partial z^2} = \frac{S_s}{K} \frac{\partial h}{\partial t} \quad \dots\dots\dots (5)$$

In transient applications (e.g. pumping tests) the right hand side of equation (2) plays an important role. Physically, this term represents the temporal change of fluid storage in the pore space, that can be separated into two components

$$\frac{1}{\rho_w} \frac{\partial(\rho_w n)}{\partial t} = \frac{n}{\rho_w} \frac{\partial \rho_w}{\partial t} + \frac{\partial n}{\partial t} \quad \dots\dots\dots (6a)$$

with $\frac{n}{\rho_w} \frac{\partial \rho_w}{\partial t}$ corresponding to the effect of the *compressibility of water* and $\frac{\partial n}{\partial t}$ corresponding to the effect of the *compressibility of the solid skeleton*.

COMPRESSIBILITY OF WATER

Under isothermal condition, the density of water ρ_w is primarily a function of the pore pressure p , and therefore the first term on the right of equation (6a) :

$$\frac{n}{\rho_w} \frac{\partial \rho_w}{\partial t} = \frac{n}{\rho_w} \frac{\partial \rho_w}{\partial P} \frac{\partial P}{\partial t} \quad \dots\dots\dots (6b)$$

Consider a fixed mass M of water with a volume V_w subjected to pore pressure P . If the pore pressure is increased isothermally by an amount ΔP , then the volume will change by a negative amount ΔV_w . Since the mass $M = \rho_w V_w$ is fixed, we have

$$\Delta M = 0 \quad \rightarrow \quad \rho_w \Delta V_w + V_w \Delta \rho_w = 0 \quad \rightarrow \quad \frac{\Delta \rho_w}{\rho_w} = - \frac{\Delta V_w}{V_w}$$

Hence, equation (6a) can be written in terms of the volume change of water as

$$\frac{n}{\rho_w} \frac{\partial \rho_w}{\partial t} = - \frac{n}{V_w} \left(\frac{\partial V_w}{\partial P} \right)_{T,M} \frac{\partial P}{\partial t} \quad \dots\dots\dots (6c)$$

But since the compressibility of water β_w is defined to be:

$$\beta_w = - \frac{1}{V_w} \left(\frac{\partial V_w}{\partial P} \right)_{T,M}$$

we can rewrite equations (6a) and (6b) as

$$\frac{n}{\rho_w} \frac{\partial \rho_w}{\partial t} = n \beta_w \frac{\partial P}{\partial t} \quad \dots\dots\dots (6d)$$

EFFECTIVE STRESS AND THE COMPRESSIBILITY OF THE SOLID MATRIX

We next consider the second term $\frac{\partial n}{\partial t}$ on the right hand side of equation (6a). By definition, the porosity $n = \frac{V_V}{V_T}$ and

therefore $\Delta n = \frac{\Delta V_V}{V_T}$. Furthermore, it is commonly observed in soil that the bulk volume change ΔV_T is primarily from

the pore volume change ΔV_V and therefore to a first approximation, we have

$$\Delta V_T \approx \Delta V_V \quad \rightarrow \quad \Delta n = \frac{\Delta V_V}{V_T} \approx \frac{\Delta V_T}{V_T}$$

And taking the limit, we arrive at: $\frac{\partial n}{\partial t} \approx \frac{1}{V_T} \frac{\partial V_T}{\partial t}$ (7)

Under isothermal conditions, the bulk volume change ΔV_T may be induced by subjecting the porous solid to an external stress $\Delta \sigma_T$ (overburden or tectonic in origin) or an internal pore pressure Δp . An increase in stress tends to decrease the bulk volume whereas an increase in pore pressure tends to increase the bulk volume. From extensive laboratory observations, Terzaghi formulated the effective stress principle, which states that the effect of the compressive stress $\Delta \sigma_T$ is exactly the opposite of the effect of the pore pressure Δp . In other words, the bulk volume change ΔV_T is simply a function of the effective stress $\sigma_e = \sigma_T - P$:

$$\Delta V_T = \Delta V_T(\sigma_e) = \Delta V_T(\sigma_T - P)$$

Applying Terzaghi's effective stress principle to equation (7), we arrive at the following expression for the temporal change of porosity with time:

$$\frac{\partial n}{\partial t} = \frac{\partial n}{\partial \sigma_e} \frac{\partial \sigma_e}{\partial t} = \frac{1}{V_T} \frac{\partial V_T}{\partial \sigma_e} \frac{\partial \sigma_e}{\partial t}$$
 (8a)

The compressibility of the porous solid (soil or rock) is defined to be $\alpha = -\frac{1}{V_T} \frac{\partial V_T}{\partial \sigma_e}$. If the loading and compaction are

uniaxial, then $\alpha = -\frac{1}{b} \frac{\partial b}{\partial \sigma_e}$ where b is the thickness. In laboratory testing, the sample is usually deformed under *drained*

condition (with the pore pressure p maintained constant throughout the sample) and therefore $\Delta \sigma_e = \Delta \sigma_T$. On the other hand, the overburden stress is relatively constant but the pore pressure varies significantly during transient flow, which implies that $\Delta \sigma_T = 0$ and $\Delta \sigma_e = -\Delta P$ in such an aquifer setting. The aquifer compressibility is then given by

$$\alpha = -\frac{1}{V_T} \frac{\partial V_T}{\partial \sigma_e} = \frac{1}{V_T} \frac{\partial V_T}{\partial P} = \frac{1}{b} \left(\frac{\partial b}{\partial P} \right)$$
 (with σ uniaxial, and fixed) (8b).

When substituted into (8a), we have

$$\frac{\partial n}{\partial t} = -\alpha \frac{\partial \sigma_e}{\partial t} = \alpha \left(\frac{\partial P}{\partial t} \right)$$
 (with σ fixed) (8c).

SPECIFIC STORAGE, POROSITY AND COMPRESSIBILITIES

We started off by separating the fluid storage into two components (equation 4a) and then we obtained explicit interpretations of these two components with respect to the compressibility of the water (equation 6c) and the compressibility of the solid matrix (equation 8c). Since definitions of the compressibilities are with respect to changes in pressure, we need to rewrite them in terms of the changes in hydraulic head. Putting all these results together, we have

$$\frac{1}{\rho_w} \frac{\partial(\rho_w n)}{\partial t} = \frac{n}{\rho_w} \frac{\partial \rho_w}{\partial t} + \frac{\partial n}{\partial t} = (n\beta_w + \alpha) \frac{\partial P}{\partial t} = \rho_w g (n\beta_w + \alpha) \frac{\partial h}{\partial t}$$
 (fixed elevation z) (9)

Comparing equations (4) and (9), the specific storage is given by:

GROUNDWATER

$$S_s = \rho_w g (n\beta_w + \alpha) \quad \dots\dots\dots (10)$$

Symbol	Meaning	Dimension
n	Porosity	none
h	Hydraulic head	L
q_x, q_y, q_z	Specific discharge (Darcian velocity) in the x , y , and z directions	$L T^{-1}$
ρ_w	Density of water	ML^{-3}
K_x, K_y, K_z	Hydraulic conductivities in the x , y and z directions	LT^{-1}
$S_s = \rho_w g (n\beta_w + \alpha)$	Specific storage	L^{-1}
α	Compressibility of solid skeleton of the soil or rock of the aquifer	$LT^2M^{-1}(L^2F^{-1})$
β_w	Compressibility of water	$LT^2M^{-1}(L^2F^{-1})$
P	Pore water pressure	$ML^{-1}T^{-2}(FL^{-2})$
σ_T	(Overburden and tectonic) stress	$ML^{-1}T^{-2}(FL^{-2})$
$\sigma_e = \sigma_T - P$	Effective stress	$ML^{-1}T^{-2}(FL^{-2})$
$S = S_s b$	for a confined aquifer of thickness b: Storativity	none
$T = Kb$	Transmissivity	$L^2 T^{-1}$
$S = S_y + S_s h$	for an unconfined aquifer of thickness h: storativity	none

Darcy's Law in Unconfined Aquifers

Fluid flow tends to be three dimensional below the water table (phreatic surface). The water table itself is a three dimensional surface. What complicates establishing equipotential lines and defining flow lines in this setting is the potential for local sources or sinks, and the local seepage face.

If no sources or sinks are present (no flux crosses the water table), then the water table represents a local flow surface (or a flow line in a two dimensional cross section) with equipotentials perpendicular to this surface.

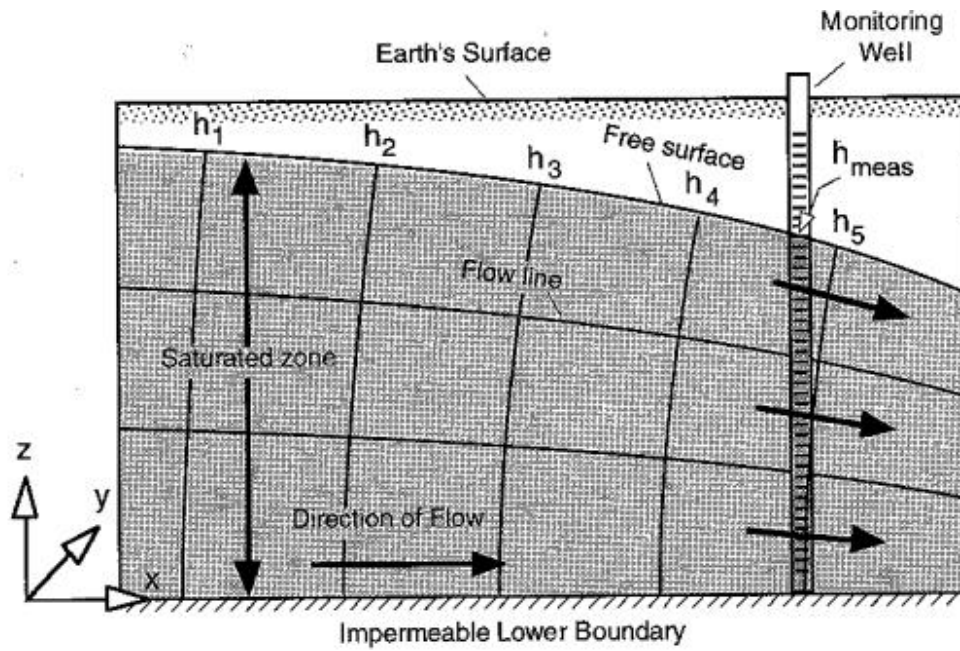

Note that $h(x,y,0) \neq h(x,y,h)$. In other words, h is dependent on z . Specifically, the head measured in the well ($h(x_5,y_5)$) is not equal to the h_5 equipotential. This difference is δh .

The question arises as to how much error is involved in assuming that is negligible? And if we make this assumption what are we saying?

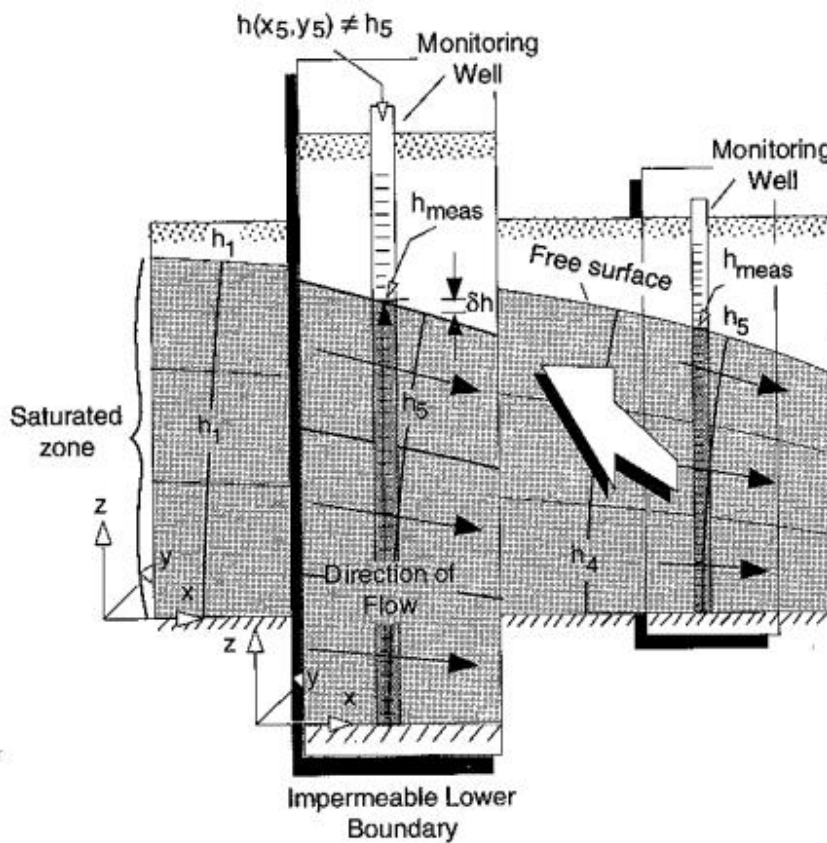

Dupuit Assumptions

Because the water table is a flow line and therefore represents a flux, assign a flux of “ q_s ” at a point representing the intersection of the well and the water table. The angle θ is the angle between “ q_s ” and the horizontal. The specific discharge is in a direction tangent to the flowline and is given by:

$$q_s = -K \frac{dh}{ds} = -K \frac{dz}{ds} = -K \sin \theta$$

Dupuit suggested that if θ is small then $\sin \theta$ could be replaced by the slope $\tan \theta = -K \frac{dh}{dx}$

This is equivalent to the assumption:

$$h(x, y, h) \cong h(x, y, 0)$$

Or,

$$\frac{\partial h}{\partial z} \cong 0$$

The above statement says that lines or surfaces of constant h are approximately vertical, and lines of flow are approximately horizontal. Therefore the specific discharge can be expressed as:

$$q_x = -K \frac{dh}{dx} \qquad q_y = -K \frac{dh}{dy}$$

And the flow per unit width can be expressed as:

$$Q_x = -K_x h \frac{\partial h}{\partial x} \qquad Q_y = -K_y h \frac{\partial h}{\partial y}$$

The important advantage gained by employing the Dupuit assumptions is that $h(x, y, z)$ has been replaced by $h(x, y)$, that is, z does not appear as an independent variable.

Also, since at a point on the free surface, $p = 0$ and $h = h(x, y)$, we assume that the vertical line through the point is also an equipotential line $h = \text{constant}$.

Because we have a free water surface we choose to use a volume balance instead of mass balance. We can do this because there is minimal system compressibility in unconfined systems. Thus, the mass change associated with compression is minimal. Most of the available water is a result of dewatering of the aquifer itself. Total thickness is now equivalent to the hydraulic head. Note that we now have a nonlinear set of equations. Our volume balance expression is:

$$V_t - V_o = \frac{\partial V}{\partial t}$$

The same principles apply here as applied for confined flow. Because of Dupuit we only need to consider volume flow through the x and y faces of our volume.

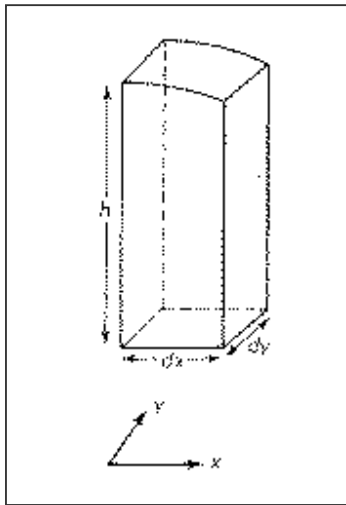

In the x-direction:

Inflow: $Q_x \Delta y$

Outflow: $\left[Q_x + \frac{\partial Q_x}{\partial x} \Delta x \right] \Delta y$

Analogous expressions can be written for the y-direction. The input and output expressions are summed as before.

The RHS of the continuity equation is formulated similarly as done before.

Combining the left and right hand sides of the continuity expression yields

Substituting our expressions for Darcy's law into the above expression yields the governing equation for unconfined flow referred to as the Boussinesq Equation. Note, this is a nonlinear expression. There are techniques to linearize this equation.

Derivation of the Dupuit equation

For the case of unconfined ground water flow, Dupuit developed a theory that allows for a simple solution based on several important assumptions:

1. The water table or free surface is only slightly inclined.
2. Streamlines may be considered horizontal and equipotential lines vertical.
3. Slopes of the free surface and hydraulic gradient are equal.

The figure shows the graphical example of Dupuit's assumptions for essentially one-dimensional flow. The free surface from $x = 0$ to $x = L$ can be derived by considering Darcy's law and the governing one-dimensional equation.

Darcy's equation:

$$q = -Kh \frac{dh}{dx}$$

Where h is the saturated thickness, and x are defined in the figure. At steady state, the rate of change of q with distance is zero or:

$$\frac{d}{dx} \left[-Kh \frac{dh}{dx} \right] = 0 \quad \text{but, } h \frac{dh}{dx} = \frac{1}{2} \frac{d}{dx} (h^2)$$

$$\frac{d}{dx} \left[-\frac{K}{2} \frac{dh^2}{dx} \right] = 0 \quad (K/2 \text{ is constant, and the derivative is for } h \text{ only})$$

GROUNDWATER

$$-\frac{K}{2} \frac{d}{dx} \left[\frac{dh^2}{dx} \right] = -\frac{K}{2} \frac{d^2(h^2)}{dx^2} = 0$$

or the governing flow equation becomes:

$$\frac{d^2(h^2)}{dx^2} = 0 \quad \text{“Dupuit - Forchheimer Equation”}$$

$$\frac{d(h^2)}{dx} = a \quad h^2 = ax + b$$

Where a , and b are constants, setting the boundary conditions $h = h_0$ at $x=0$.

$$h_0^2 = a \times 0 + b$$
$$b = h_0^2$$

Differentiating $h^2 = ax + b$, gives: $\frac{d}{dx} h^2 = \frac{d}{dx} (ax + b)$

$$2h \frac{dh}{dx} = a$$

From Darcy' law, $h \frac{dh}{dx} = -\frac{q}{K}$

Substitute into $h^2 = ax + b$:

$$h^2 = 2h \frac{dh}{dx} x + h_0^2 \quad \rightarrow \quad h^2 = -\frac{2q}{K} x + h_0^2$$

Setting the boundary conditions $h = h_L$ at $x=L$.

$$h_L^2 = -\frac{2q}{K} L + h_0^2 \quad \dots\dots\dots (\#)$$

Rearranging the equation gives:

$$q = \frac{K}{2L} (h_0^2 - h_L^2)$$

Then the general equation for the shape of the parabola is:

$$h^2 = h_0^2 - \frac{x}{L} (h_0^2 - h_L^2)$$

GROUNDWATER

Forms of Boussinesq Equation

1- Heterogeneous-anisotropic

2- Homogeneous-anisotropic

3- Homogeneous-isotropic

Example:

A canal was constructed running parallel to a river. The canal and river are connected by a sand aquifer ($K = 12$ ft/day) and are separated by a distance of 1500 ft. Water level elevations are 31 ft in the river, and 27 ft in the canal. Annual rainfall rate is 32 in/year and evapotranspiration is 18 in/year. Based on soil type and land use, a runoff coefficient is estimated to be 0.25.

Determine: (a) the distance to the groundwater divide, (b) the maximum water table elevation, (c) the discharge rate per 100 ft width into the river, and (d) the discharge rate per 100 ft width into the canal.

Note: Base of aquifer elevation = 10 ft above mean sea level.

Solution:

Water budget equation for the aquifer:

$$Q_{in} = Q_{out} \qquad P = R_o + ET + q_R$$

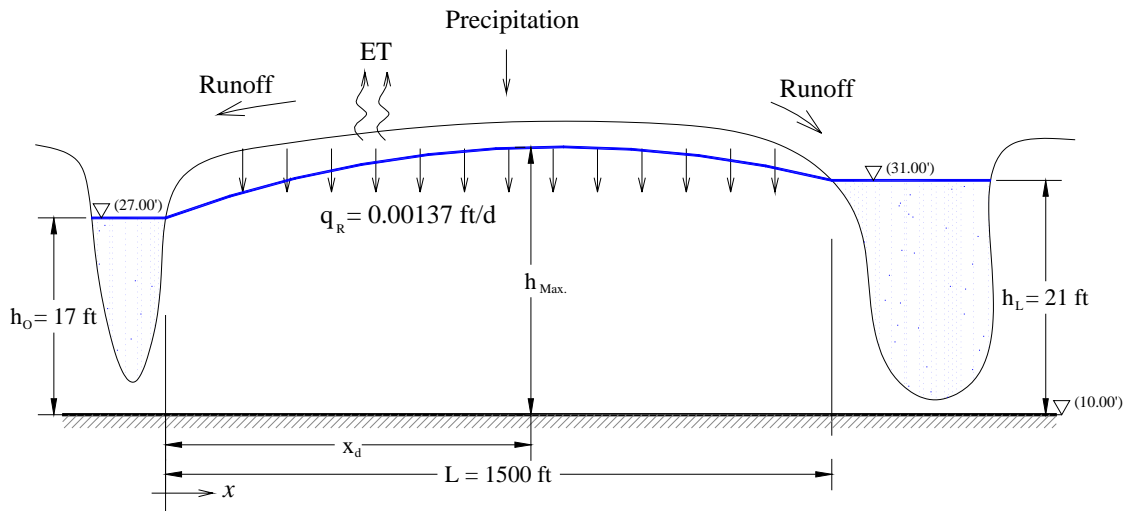

Runoff coefficient = 0.25 means that 25% of the precipitation will be direct runoff → $R_o = 0.25 P$

$$P = 0.25P + ET + q_R$$

$$q_R = 0.75P - ET \qquad q_R = 0.75 \times 32 \frac{\text{in}}{\text{yr}} - 18 \frac{\text{in}}{\text{yr}} = 6 \text{ in/yr}$$

$$6 \frac{\text{in}}{\text{yr}} \frac{\text{ft}}{12 \text{ in}} \frac{\text{yr}}{365 \text{ d}} = \mathbf{0.00137 \text{ ft/day}}$$
 (you multiply this value by the surface area to get the flowrate)

(A) The distance to the groundwater divide:

The groundwater divide is at maximum head value (at $\frac{\partial h}{\partial x} = 0$)

$$x_d = \frac{L}{2} - \frac{K}{2 \cdot q_R \cdot L} (h_0^2 - h_L^2) \qquad x_d = \frac{1500}{2} - \frac{12}{2 \times 0.00137 \times 1500} (17^2 - 21^2)$$

$$x_d = 1,193.8 = 1194 \text{ ft}$$

(B) The maximum water table elevation, h_{max} :

$$h_{\text{max}} = \sqrt{h_0^2 - \frac{(h_0^2 - h_L^2)}{L} \cdot x_d + \frac{q_R}{K} (L - x_d) \cdot x_d}$$

$$h_{\text{max}} = \sqrt{17^2 - \frac{(17^2 - 21^2)}{1500} \times 1193.79 + \frac{0.00137}{12} (1500 - 1193.79) \times 1193.79}$$

$$h_{\text{max}} = 21.25 \text{ ft}$$

(C) The discharge rate per 100 ft width into the river

GROUNDWATER

$$U(x) = \frac{K}{2.L} (h_0^2 - h_L^2) - q_R \cdot \left(\frac{L}{2} - x \right) \quad (\text{flux per unit width})$$

at the river, $x = L$

$$U(1500) = \frac{12}{2 \times 1500} (17^2 - 21^2) - 0.00137 \left(\frac{1500}{2} - 1500 \right)$$

$$Q_{\text{unit-width}} = 0.41939726 \text{ ft}^3/\text{day}/\text{ft} \rightarrow$$

$$Q \text{ (for 100 ft width)} = Q_{\text{unit-width}} \times W = 0.42 \times 100 = \mathbf{42.0 \text{ ft}^3/\text{day}} \rightarrow$$

(D) The discharge rate per 100 ft width into the canal.

At the canal, $x = 0$

$$U(0) = \frac{12}{2 \times 1500} (17^2 - 21^2) - 0.00137 \left(\frac{1500}{2} \right)$$

$$Q_{\text{unit-width}} = -1.6354 \text{ ft}^3/\text{day}/\text{ft} \quad \leftarrow$$

$$Q \text{ (for 100 ft width)} = Q_{\text{unit-width}} \times W = -1.6354 \times 100 = \mathbf{-163.54 \text{ ft}^3/\text{day}} \leftarrow$$

Special case solution:

Recharge with uniform boundary conditions:

$$h(x) = \sqrt{h_0^2 - \frac{(h_0^2 - h_L^2)}{L} \cdot x + \frac{q_R}{K} (L - x) \cdot x}$$

if $h_0 = h_L$, then

$$h(x) = \sqrt{h_0^2 + \frac{q_R}{K} (L - x) \cdot x}$$

and

$$h_{\text{max.}} = \sqrt{h_0^2 - \frac{(h_0^2 - h_L^2)}{L} \cdot x_d + \frac{q_R}{K} (L - x_d) \cdot x_d} \rightarrow \text{will be } h_{\text{max.}} = \sqrt{h_0^2 + \frac{q_R L^2}{4K}}$$

$$q'(x) = \frac{K}{2.L} (h_0^2 - h_L^2) - q_R \cdot \left(\frac{L}{2} - x \right) \rightarrow \text{will be } q'(x) = -q_R \cdot \left(\frac{L}{2} - x \right)$$

$$q'(0) = -q_R \cdot \left(\frac{L}{2} \right)$$

GROUNDWATER

$$q'(L) = q_R \cdot \left(\frac{L}{2}\right)$$

$$x_d = \frac{L}{2} - \frac{K}{2 \cdot q_R \cdot L} (h_0^2 - h_L^2) \quad \rightarrow \quad \text{will be} \quad x_d = \frac{L}{2}$$

Example

The town of Hubbertville is planning to expand its water supply by constructing a well in the unconfined aquifer shown below. The well is designed to pump constantly at 20,000 m³/day (5.3 mgd). The State Fish and Game Service, managers of the Green Swamp Conservation Area, claim that the proposed withdrawal will “significantly reduce” the groundwater discharge to the swamp and damage waterfowl habitat. The town engineer claims that the river and the groundwater divide will prevent any change in flow to the swamp.

- 1- Under pre-development conditions, determine the location of the groundwater divide, maximum water table height, flow rate per unit width (Q_{u-w}) and total volumetric flow rate (Q) to Green Swamp prior to pumping. Assume steady, horizontal, unidirectional flow and steady, uniform recharge ($q_R = 0.001$ m/d).
- 2- Preliminary model results show that the groundwater divide will move 750 m to the south and remain in a stable position with the pumping well in operation. Determine the projected Q to the swamp.

Solution

1- The situation without the well:

$$h_0 = h_L$$

$$x_d = \frac{L}{2} = \frac{10,000}{2} = 5000 \text{ m}$$

$$h_{\max.} = \sqrt{h_0^2 + \frac{q_R L^2}{4K}}$$

$$h_0 = 1000 - 980 = 20 \text{ m}$$

$$h_{\max.} = \sqrt{20^2 + \frac{0.001 \times 10,000^2}{4 \times 50}} = 30 \text{ m (Elevation} = 980 + 30 = 1010 \text{ m)}$$

$$q'(0) = -q_R \cdot \left(\frac{L}{2}\right) (\text{River}) = -0.001 \times \left(\frac{10,000}{2}\right) = -5.0 \text{ m}^3/\text{d/m} \quad \leftarrow$$

$$Q_{\text{River}} = q' \times W = -5 \times 4,500 = -22,500 \text{ m}^3/\text{d} \quad \leftarrow$$

$$q'(L) = q_R \cdot \left(\frac{L}{2}\right) (\text{Swamp}) = 0.001 \times \left(\frac{10,000}{2}\right) = 5.0 \text{ m}^3/\text{d/m} \quad \rightarrow$$

GROUNDWATER

$$Q_{Swamp} = q' \times W = 5 \times 4,500 = 22,500 \text{ m}^3/\text{d} \rightarrow$$

2- The well is operating

Operating the well will cause the water divide to move south a distance of 750 m

The groundwater divide is a no-flow boundary, which means that it diverts the groundwater flux into two directions (north and south in this case).

The only input to the system is the recharge

Recharge area going to the swamp (after the well is operated) = 4500×4250

Flux to the swamp = recharge rate \times area

$$= 0.001 \text{ m/d} \times (4500 \times 4250) \text{ m}^2$$

$$= 19,125 \text{ m}^3/\text{d}$$

Difference in groundwater flux to the swamp due to operating the well = $22,500 - 19,125$

$$= 3,375 \text{ m}^3/\text{d}$$

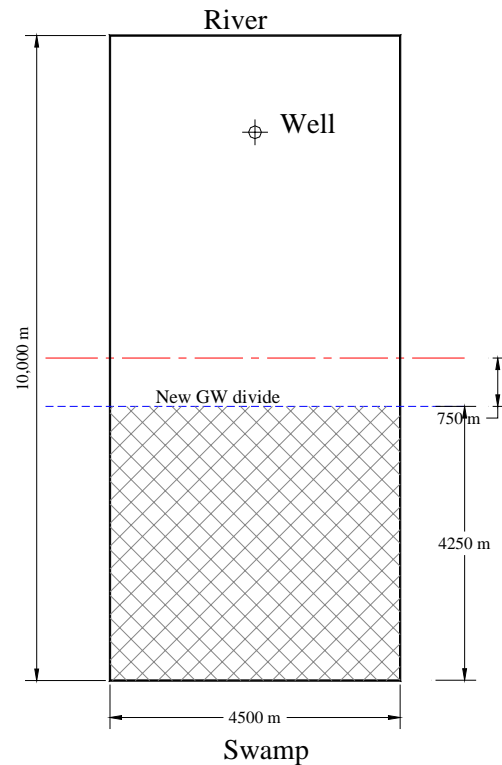

Capture Zone Analysis

Capture zone: up- and down-gradient areas that will drain into a pumping well. If the water table is perfectly flat, the capture zone will be circular and correspond to the cone of depression.

Defining Capture Zones: Confined Aquifer

Capture zone half-width can be estimated for a confined aquifer using the following equation:

$$y_{\max} = \pm \frac{Q}{2Kbi}$$

- Q is the pumping rate.
- K is the hydraulic conductivity .
- b is the initial thickness of the aquifer.
- i is the hydraulic gradient before pump starts.

GROUNDWATER

Distance from the stagnation point that marks the end of the capture zone in the down-gradient direction to the pumping

well is $x_o = \frac{-Q}{2\pi K b i}$

Defining Capture Zones: Unconfined Aquifer

$$y_{\max} = \pm \frac{QL}{K(h_1 - h_2)}$$

$$x_o = \frac{-QL}{\pi K(h_1 - h_2)}$$

Example

Calculate the capture zone maximum width and the distance between the stagnation point and the pumping well for a well with a pumping rate of 1500 m³/day, confined aquifer of hydraulic conductivity 425 m/day, an initial hydraulic gradient of 0.00098, and aquifer thickness of 22 m.

Capture Zone Length

Use concepts of advection, dispersion, retardation, etc. to determine a safe groundwater travel time for determining a capture zone "length".

Example

Data:

The flow direction is due south.
Specific discharge (q) = 0.24 ft/day.
The aquifer is confined with vertical thickness (b) = 75.0 ft.
Aquifer Transmissivity (T) = 1240 ft²/day.
Design pumping rate (Q) = 198 gpm.

Required:

- a- The capture width of the new well.
- b- The distance to the stagnation point, and the location on the figure.
- c- Is Nest 3 lies inside or outside the capture curve?

Solution:

width of capture curve (for a confined aquifer) = $2|y_{\max}| = \frac{Q}{T.i}$

Where:

T Aquifer transmissivity = $k \cdot b$
k Hydraulic conductivity
b Aquifer thickness.

$$W = \frac{Q}{k.b.i} \quad , \text{and} \quad q = k.i \quad W = \frac{Q}{q.b}$$

GROUNDWATER

1.0 ft³ = 7.48 gal.

$$1.0 \text{ gal/min} = \frac{\text{gal}}{\text{min}} * \frac{\text{ft}^3}{7.48 \text{ gal}} * \frac{24 * 60 \text{ min}}{\text{day}} = 192.513 \text{ ft}^3/\text{day}$$

$$Q = 198 * 192.513 = 38117.647 \text{ ft}^3/\text{day}$$

$$W = \frac{Q}{q.b} = \frac{38117.647(\text{ft}^3 / \text{day})}{0.24(\text{ft} / \text{day}) * 75(\text{ft})} = 2117.647 \text{ ft} \quad \dots\dots\dots (a)$$

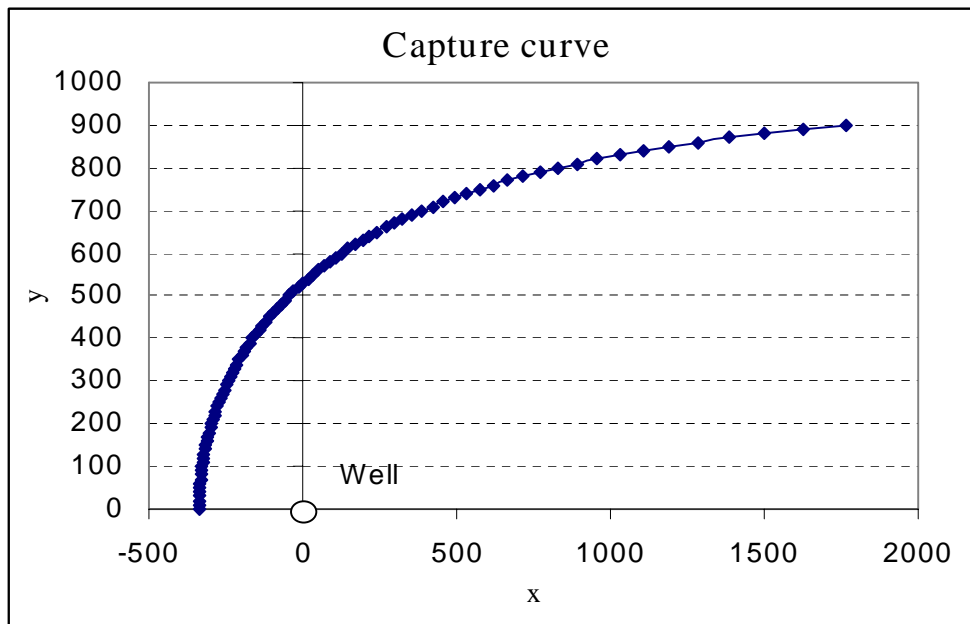

Equation of the capture curve:

$$x = \frac{-y}{\tan\left(\frac{y}{x_0}\right)}$$

where

x_0 distance to stagnation point.

$$x_0 = \frac{-Q}{2\pi.T.i} = \frac{-Q}{2\pi.kbi} = \frac{-Q}{2\pi.q.b}$$

$$x_0 = \frac{-38117.647}{2\pi(0.24 * 75)} = -337.034 \text{ ft}$$

$$y_{\text{max.}} = W/2 = 2117.647 / 2 = 1058.8 \text{ ft}$$